

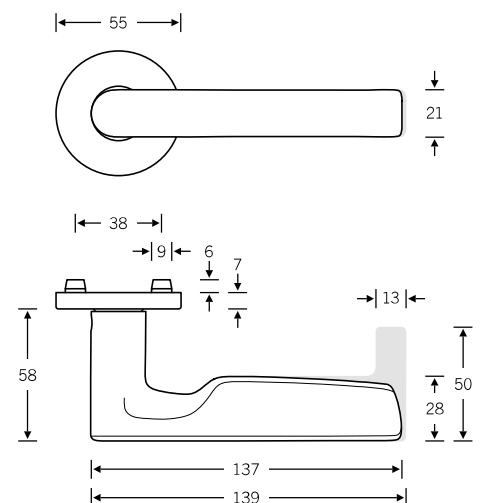

Helmut Jahn and Yorgo Lykouria came to door handle design without any preconceptions whatsoever. Freeing their minds of the constraints of industrial production processes, they sought a shape combining geometrical and ergonomic elements. The upshot is a genuine innovation of the moulded-to-the-hand concept.



Design: Helmut Jahn, Yorgo Lykouria

 EN 179 model: FSB 1094
 Lever handle with return-to-door

Other variants:
 – square roses
 – oval/angular backplates

Plug-in handle for doors

15 1093

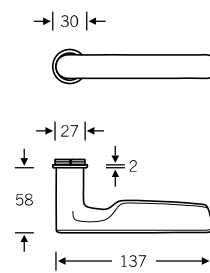

4

Window handle

Plug-in handle for windows

34 1093

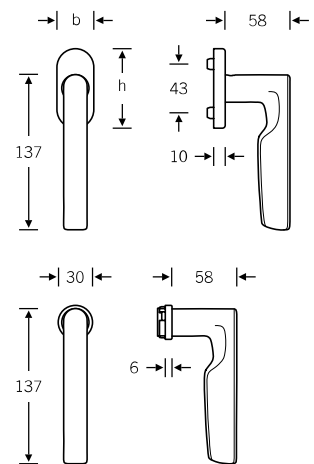

Lever handles for narrow-stile doors

09 1094 (in-line, EN 179)
06 1094 (cranked, EN 179)

Option without return-to-door:
09 1093 (in-line)
06 1093 (cranked)

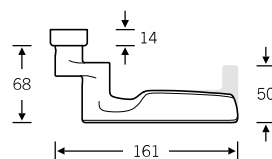
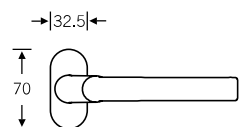
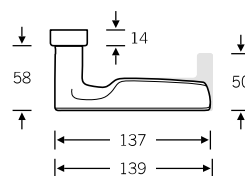
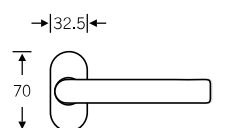

Doorknob for narrow-stile doors

07 0846 (cranked)

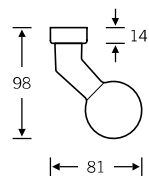
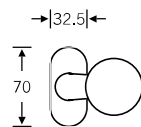

Glass door fitting

13 4223 with 72 1093

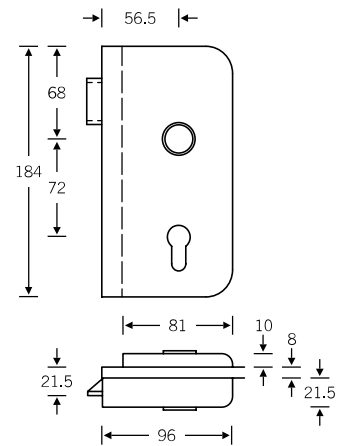

4

Lever/knob sets

Doorknob for flush doors

Knob backplates

Aluminium X = 77 mm
Stainless steel X = 73 mm

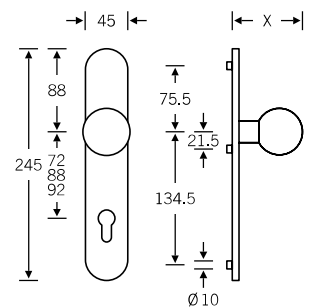
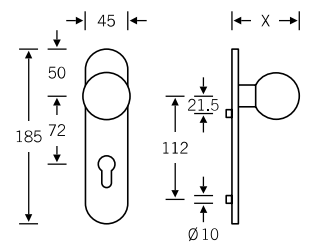
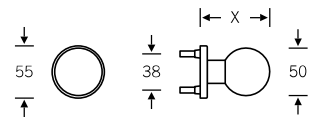

Product codes for the lever/knob sets can be found on the following pages; for individual components, see page 328 ff.

Lever/lever sets

Broad backplate sets available upon request; for flush-fitted roses, see page 386 f.

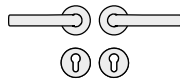

- 12 1093 013 (N)
- 72 1093 613 (R)
- 76 1093 613 (R)
- 79 1094 613 (R)

- 72 1093 614 (L)
- 76 1093 614 (L)
- 79 1094 614 (L)

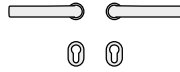

- 15 1093 013 (N)

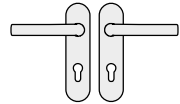

- 12 1093 007 (N)
- 72 1093 607 (R)
- 76 1093 607 (R)
- 79 1094 607 (R)

- 72 1093 608 (L)
- 76 1093 608 (L)
- 79 1094 608 (L)

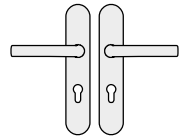

- 12 1093 027 (N)
- 72 1093 627 (R)
- 76 1093 627 (R)
- 79 1094 627 (R)

- 72 1093 628 (L)
- 76 1093 628 (L)
- 79 1094 628 (L)

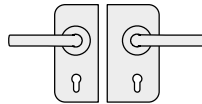

- 13 4223 041 (R) with 10 1093 00500 (N)
- 13 4223 042 (R) with 12 1093 013 (N)
- 13 4223 042 (R) with 72 1093 613 (R)

- 13 4223 051 (L) with 10 1093 00500 (N)
- 13 4223 052 (L) with 12 1093 013 (N)
- 13 4223 052 (L) with 72 1093 614 (L)

Sets for narrow-stile doors

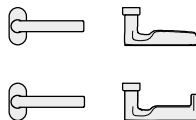

- 09 1093 211
- 09 1093 212
- 09 1094 212
- 09 1094 223 (ILS)

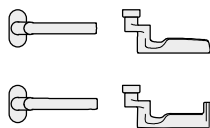

- 06 1093 111
- 06 1093 112
- 06 1094 112
- 06 1093 023 (ILS)
- 06 1094 023 (ILS)



- 07 0846 228 (fixed; aluminium and stainless steel)
- 07 0846 228 (fixed; stainless steel)
- 07 0846 428 (fixed; aluminium)



- 17 1757

Lever/knob sets

Broad backplate sets available upon request

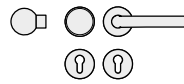

- | | |
|-------------------|-----------------|
| 12 1093 015 (N) | 72 1093 616 (L) |
| 72 1093 615 (R) | 76 1093 616 (L) |
| 76 1093 615 (R) | 79 1094 616 (L) |
| 79 1094 615 (R) | |
| 79 1094 619 (ILS) | |

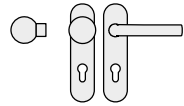

- | | |
|-------------------|-----------------|
| 12 1093 009 (N) | 72 1093 610 (L) |
| 72 1093 609 (R) | 76 1093 610 (L) |
| 76 1093 609 (R) | 79 1094 610 (L) |
| 79 1094 609 (R) | |
| 79 1094 611 (ILS) | |

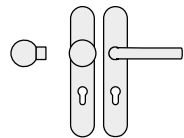

- | | |
|-------------------|-----------------|
| 12 1093 029 (N) | 72 1093 630 (L) |
| 72 1093 629 (R) | 76 1093 630 (L) |
| 76 1093 629 (R) | 79 1094 630 (L) |
| 79 1094 629 (R) | |
| 79 1094 631 (ILS) | |

WC sets

Broad backplate sets available upon request;
for flush-fitted roses, see page 386 f.

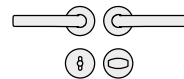

- | | |
|-----------------|-----------------|
| 12 1093 019 (N) | 72 1093 620 (L) |
| 72 1093 619 (R) | |

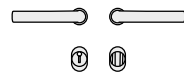

- | |
|-----------------|
| 15 1093 019 (N) |
|-----------------|

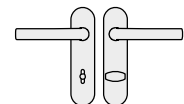

- | | |
|-----------------|-----------------|
| 12 1093 011 (N) | 72 1093 612 (L) |
| 72 1093 611 (R) | |

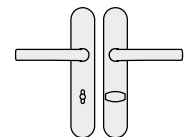

- | | |
|-----------------|-----------------|
| 12 1093 031 (N) | 72 1093 632 (L) |
| 72 1093 631 (R) | |

Window handles



- 34 1093 09030 (rose 27 × 62 × 10)
- 34 1093 09039 (rose 32.5 × 70 × 10)
- 34 1093 09034 (rose 25.5 × 60.5 flush-fitted)
- 34 1093 170 (lock adaptor RC 1–6)
- 34 1093 076 (lock adaptor with push-button RC 1–6)
- 34 1093 711 (plug-in handle for timber/metal profiles, Ø 30)
- 34 1093 751 (plug-in handle for PVC profiles, Ø 30)
- 34 1093 714 (plug-in handle, lock adaptor RC 1–6)
- 34 1093 717 (plug-in handle with push-button RC 1–6)

N = non-handed
R = DIN RH, opening inwards
L = DIN LH, opening inwards
ILS = inactive-leaf set

Female handles
 Plug-in handle for doors
 FSB ASL®

FSB ASL®
 FS heavy-duty fitting
 EN 179 heavy-duty fitting

For bearings, see page 52 ff.