

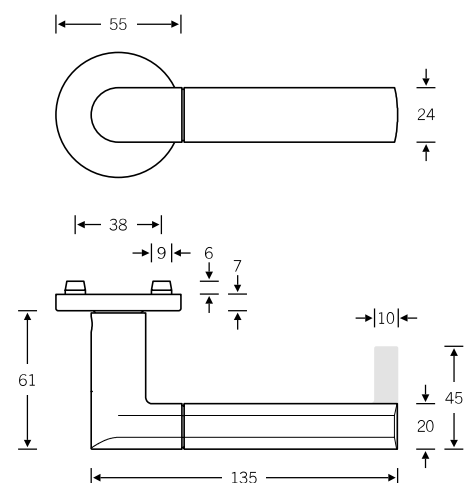

Christoph Ingenhoven was inspired by the quintessential classic, the FSB 1076, which he reinterpreted both in the mitring and the grip section. What's so especially pleasing about this FSB 1078 model is the formal transition from a round neck to a grip section that is flat at the top and bottom. The companion variant with a return-to-door supplements the open model with a closed design conforming to EN 179.



Design: Christoph Ingenhoven

 EN 179 model: FSB 1088
 Lever handle with return-to-door

Other variants:
 – square roses
 – oval/angular backplates

Plug-in handle for doors

15 1078

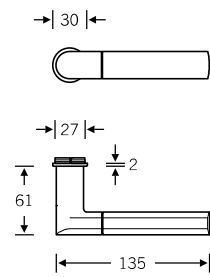

4

Window handle

Plug-in handle for windows

34 1078

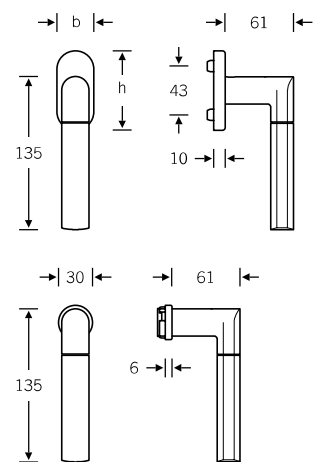

Lever handles for narrow-stile doors

09 1088 (in-line, EN 179)
06 1088 (cranked, EN 179)

Option without return-to-door:
09 1078 (in-line)
06 1078 (cranked)

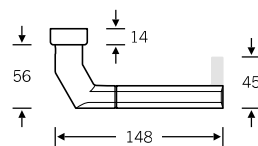
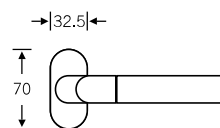
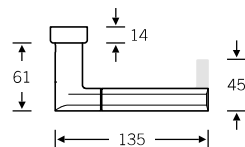
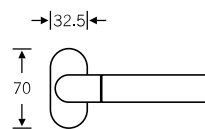

Doorknob for narrow-stile doors

07 0809 (cranked)

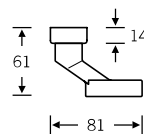
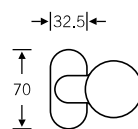

Glass door fitting

13 4220 with 10 1078

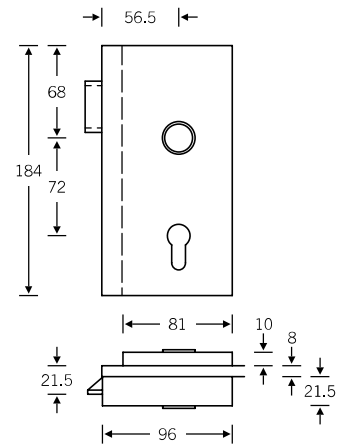

4

Lever/knob sets

Doorknob for flush doors

Knob backplates

Aluminium $\varnothing = 50$
Stainless steel $\varnothing = 55$

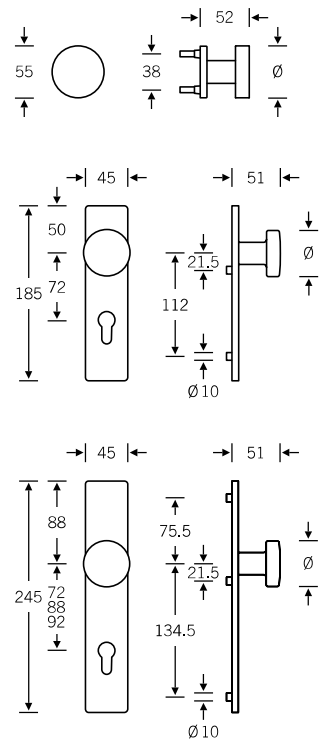

Product codes for the lever/knob sets can be found on the following pages; for individual components, see page 328 ff.

Lever/lever sets

Broad backplate sets available upon request; for flush-fitted roses, see page 536 f.

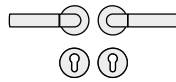

- 12 1078 013 (N)
- 72 1078 613 (R)
- 76 1078 613 (R)
- 79 1088 613 (R)
- 72 1078 614 (L)
- 76 1078 614 (L)
- 79 1088 614 (L)

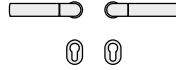

- 15 1078 013 (N)

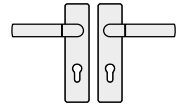

- 12 1078 001 (N)
- 72 1078 601 (R)
- 76 1078 601 (R)
- 79 1088 601 (R)
- 72 1078 602 (L)
- 76 1078 602 (L)
- 79 1088 602 (L)

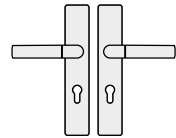

- 12 1078 021 (N)
- 72 1078 621 (R)
- 76 1078 621 (R)
- 79 1088 621 (R)
- 72 1078 622 (L)
- 76 1078 622 (L)
- 79 1088 622 (L)

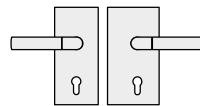

- 13 4220 041 (R) with 10 1078 00500 (N)
- 13 4220 042 (R) with 12 1078 013 (N)
- 13 4220 042 (R) with 72 1078 613 (R)
- 13 4220 090* with 76 1078 613 (R)
- 13 4220 090* with 79 1088 913 (N)
- 13 4220 051 (L) with 10 1078 00500 (N)
- 13 4220 052 (L) with 12 1078 013 (N)
- 13 4220 052 (L) with 72 1078 614 (L)
- 13 4220 090* with 76 1078 614 (L)

Sets for narrow-stile doors

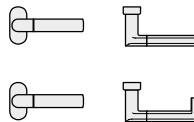

- 09 1078 211
- 09 1078 212
- 09 1088 212
- 09 1088 223 (ILS)

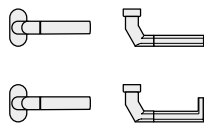

- 06 1078 111
- 06 1078 112
- 06 1088 112
- 06 1078 023 (ILS)
- 06 1088 023 (ILS)



- 07 0809 228 (fixed; aluminium and stainless steel)
- 07 0809 228 (fixed; stainless steel)
- 07 0809 428 (fixed; aluminium)



- 17 1757

* Fire safety and EN 179 variants available only in stainless steel; for variants, see page 508

Lever/knob sets

Broad backplate sets available upon request;
for flush-fitted roses, see page 536 f.

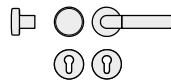

- | | |
|-------------------|-----------------|
| 12 1078 017 (N) | 72 1078 618 (L) |
| 72 1078 617 (R) | 76 1078 618 (L) |
| 76 1078 617 (R) | 79 1088 618 (L) |
| 79 1088 617 (R) | |
| 79 1088 619 (ILS) | |

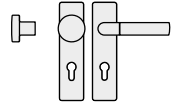

- | | |
|-------------------|-----------------|
| 12 1078 003 (N) | 72 1078 604 (L) |
| 72 1078 603 (R) | 76 1078 604 (L) |
| 76 1078 603 (R) | 79 1088 604 (L) |
| 79 1088 603 (R) | |
| 79 1088 605 (ILS) | |

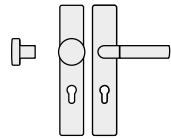

- | | |
|-------------------|-----------------|
| 12 1078 023 (N) | 72 1078 624 (L) |
| 72 1078 623 (R) | 76 1078 624 (L) |
| 76 1078 623 (R) | 79 1088 624 (L) |
| 79 1088 623 (R) | |
| 79 1088 625 (ILS) | |

WC sets

Broad backplate sets available upon request;
for flush-fitted roses, see page 536 f.

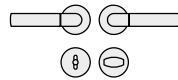

- | | |
|-----------------|-----------------|
| 12 1078 019 (N) | 72 1078 620 (L) |
| 72 1078 619 (R) | |

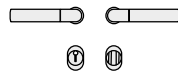

- | |
|-----------------|
| 15 1078 019 (N) |
|-----------------|

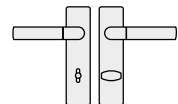

- | | |
|-----------------|-----------------|
| 12 1078 005 (N) | 72 1078 606 (L) |
| 72 1078 605 (R) | |

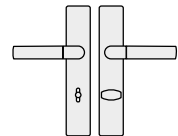

- | | |
|-----------------|-----------------|
| 12 1078 025 (N) | 72 1078 626 (L) |
| 72 1078 625 (R) | |

Window handles



- 34 1078 09030 (rose 27 × 62 × 10)
- 34 1078 09039 (rose 32.5 × 70 × 10)
- 34 1078 09034 (rose 25.5 × 60.5 flush-fitted)
- 34 1078 170 (lock adaptor RC 1–6)
- 34 1078 076 (lock adaptor with push-button RC 1–6)
- 34 1078 711 (plug-in handle for timber/metal profiles, Ø 30)
- 34 1078 751 (plug-in handle for PVC profiles, Ø 30)
- 34 1078 714 (plug-in handle, lock adaptor RC 1–6)
- 34 1078 717 (plug-in handle with push-button RC 1–6)

N = non-handed
R = DIN RH, opening inwards
L = DIN LH, opening inwards
ILS = inactive-leaf set

Female handles
 Plug-in handle for doors
 FSB ASL®

FSB AGL®
 FS heavy-duty fitting
 EN 179 heavy-duty fitting

For bearings, see page 52 ff.