

The FSB 1058 was Johannes Potente's own personal favourite. It is not known why, only two years after designing his superlative FSB 1051, he followed it up with this redesign. The FSB 1058 is one of four models designed by Johannes Potente now on permanent display at the MoMA in New York.

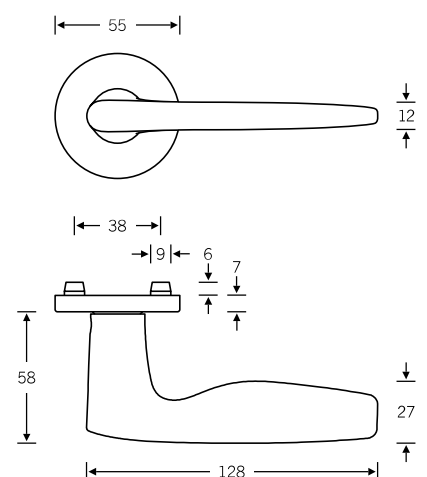

Design: Johannes Potente

Other variants:
– square roses
– oval/angular backplates

Plug-in handle for doors

15 1058

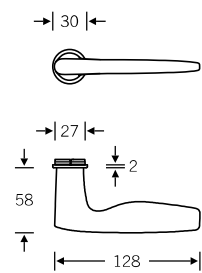

4

Window handle

Plug-in handle for windows

34 1058

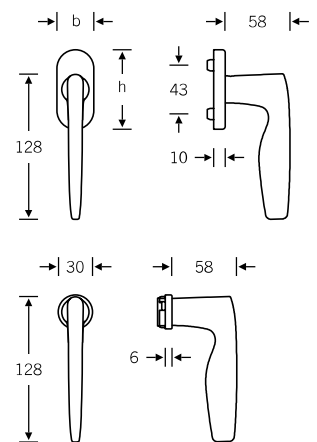

Lever/lever sets

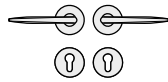

➤ 12 1058 013 (N)

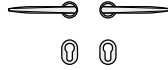

➤ 15 1058 013 (N)

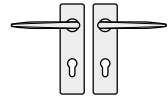

➤ 12 1058 001 (N)

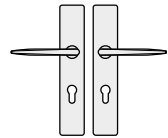

➤ 12 1058 021 (N)

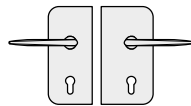

➤ 13 4223 041 (R) with
10 1058 00500 (N)
➤ 13 4223 042 (R) with
12 1058 013 (N)

➤ 13 4223 051 (L) with
10 1058 00500 (N)
➤ 13 4223 052 (L) with
12 1058 013 (N)

Lever/knob sets

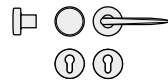

➤ 12 1058 017 (N)

For associated knobs, see page 328 f.

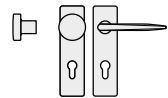

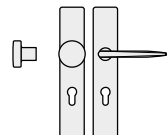

➤ 12 1058 003 (N)

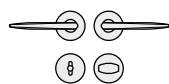

➤ 12 1058 023 (N)

WC sets



 12 1058 019 (N)

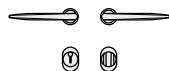

 15 1058 019 (N)

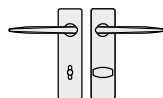

 12 1058 005 (N)

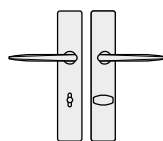



 12 1058 025 (N)



Window handles



- 34 1058 09030 (rose 27 × 62 × 10)
- 34 1058 09039 (rose 32.5 × 70 × 10)
- 34 1058 170 (lock adaptor RC 1–6)
- 34 1058 076 (lock adaptor, with push-button RC 1–6)
- 34 1058 711 (plug-in handle for timber/metal profiles, Ø 30)
- 34 1058 751 (plug-in handle for PVC profiles, Ø 30)

N = non-handed
 R = DIN RH, opening inwards
 L = DIN LH, opening inwards
 ILS = inactive-leaf set

 Female handles
 Plug-in handle for doors
 FSB ASL®

 FSB AGL®
 FS heavy-duty fitting
 EN 179 heavy-duty fitting

For bearings, see page 52 ff.