

The FSB 1051 lever handle model has come to epitomise FSB. The 'Schneider Handle' was one of Johannes Potente's supreme creation and a market leader in the 1960s. It exudes great harmony with its moulded-to-the-hand styling. The FSB 1051 is one of four models designed by Johannes Potente now on permanent display at the MoMA in New York.

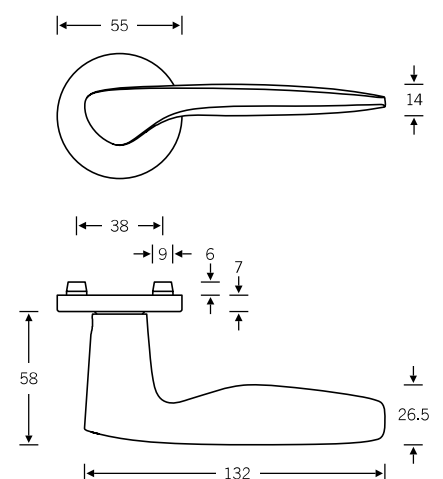

Design: Johannes Potente
 Pictured: right-hand model

- Other variants:
- square roses
 - oval/angular backplates

Plug-in handle for doors

15 1051

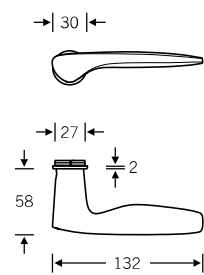

4

Window handle

Plug-in handle for windows

34 1058

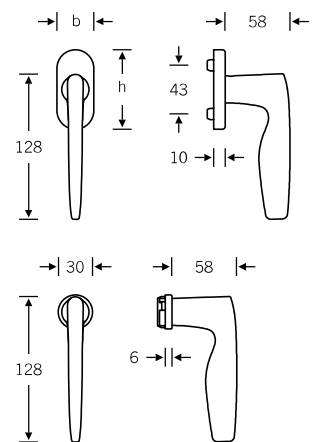

Lever/lever sets

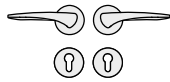

➤ 12 1051 013 (N)

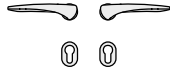

➤ 15 1051 013 (N)

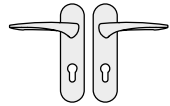

➤ 12 1051 007 (N)

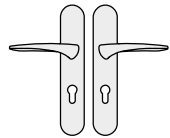

➤ 12 1051 027 (N)

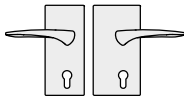

➤ 13 4224 042 (R) with
10 1051 00500 (N)

➤ 13 4224 052 (L) with
10 1051 00500 (N)

Lever/knob sets

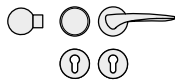

➤ 12 1051 015 (R)

➤ 12 1051 016 (L)

For associated knobs, see page 328 f.

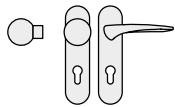

➤ 12 1051 009 (R)

➤ 12 1051 010 (L)

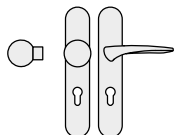

➤ 12 1051 029 (R)

➤ 12 1051 030 (L)

WC sets

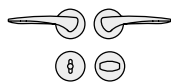

 12 1051 019 (N)

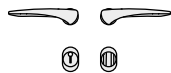

 15 1051 019 (N)

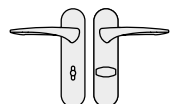

 12 1051 011 (N)

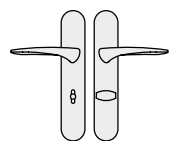

 12 1051 031 (N)



Window handles



- 34 1058 09030 (rose 27 × 62 × 10)
- 34 1058 09039 (rose 32.5 × 70 × 10)
- 34 1058 170 (lock adaptor RC 1–6)
- 34 1058 076 (lock adaptor with push-button RC 1–6)
- 34 1058 711 (plug-in handle for timber/metal profiles, Ø 30)
- 34 1058 751 (plug-in handle for PVC profiles, Ø 30)

N = non-handed
 R = DIN RH, opening inwards
 L = DIN LH, opening inwards
 ILS = inactive-leaf set

 Female handles
 Plug-in handle for doors
 FSB ASL®

 FSB AGL®
 FS heavy-duty fitting
 EN 179 heavy-duty fitting

For bearings, see page 52 ff.