

Catalogue No. 6 published by the S. A. Loevy bronzeware factory in the 1930s contained a variety of door fittings by Rachlis, Grenander, Behrens, Wagenfeld and Paul, where a circular neck was combined with a flat grip section. The FSB 1021 is an equally timeless variation on this design principle.

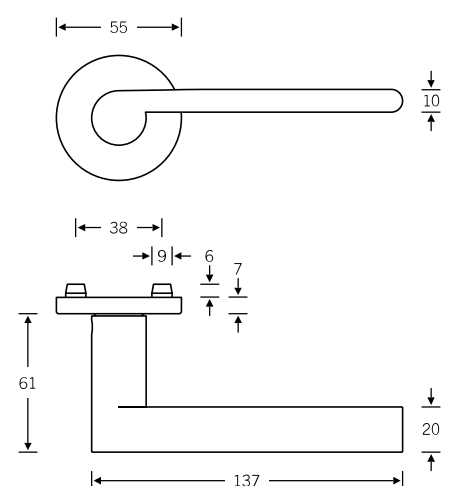

Pictured: right-hand model

Other variants:
 – square roses
 – oval/angular backplates

Plug-in handle for doors

15 1021

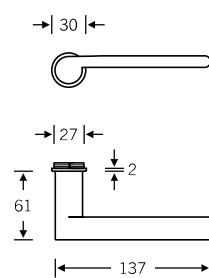

4

Window handle

34 1021

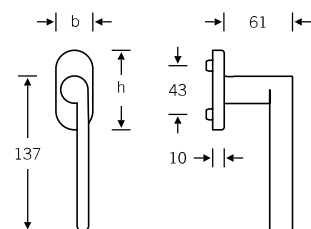

FSB 1021

Lever/lever sets

Broad backplate sets available upon request; for flush-fitted roses, see page 386 f.

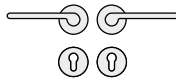

➤ 12 1021 013 (N)

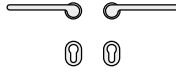

➤ 15 1021 013 (N)

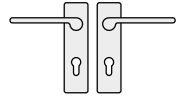

➤ 12 1021 001 (N)

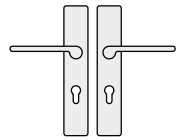

➤ 12 1021 021 (N)

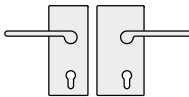

➤ 13 4224 042 (R) with
10 1021 00500 (N)

➤ 13 4224 052 (L) with
10 1021 00500 (N)

Lever/knob sets

Broad backplate sets available upon request; for associated knobs, see page 328 f.

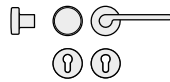

➤ 12 1021 017 (R)

➤ 12 1021 018 (L)

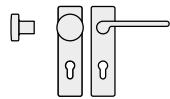

➤ 12 1021 003 (R)

➤ 12 1021 004 (L)

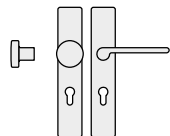



➤ 12 1021 023 (R)

➤ 12 1021 024 (L)

WC sets

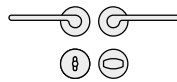
Broad backplate sets available upon request;
for flush-fitted roses, see page 386 f.



 12 1021 019 (N)

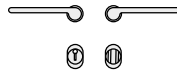

 15 1021 019 (N)

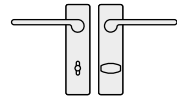

 12 1021 005 (N)

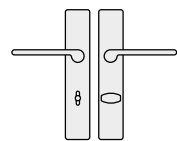



 12 1021 025 (N)



Window handles



34 1021 49039 (R) | 59039 (L) (rose 32.5 × 70 × 10)
34 1021 470 (R) | 570 (L) (lock adaptor RC 1–6)
34 1021 476 (R) | 576 (L) (lock adaptor with push-button RC 1–6)

N = non-handed
R = DIN RH, opening inwards
L = DIN LH, opening inwards
ILS = inactive-leaf set

 Female handles
 Plug-in handle for doors
 FSB ASL®

 FSB AGL®
 FS heavy-duty fitting
 EN 179 heavy-duty fitting

For bearings, see page 52 ff.