

METRIC
Bathroom Accessories



METRIC
Bathroom Accessories

METRIC in detail



The bathroom is increasingly becoming a place for tranquillity and relaxation. As a result, notions of how such spaces are designed are having to be reconsidered too. The concept of “atmosphere” has begun to play an ever more important part alongside purely functional requirements.

Factors such as “naturalness”, “simplicity” and “feeling good” are setting new standards both in the domestic sphere and in hotels and public areas. Growing significance attaches in the process to the selection and combination of natural materials, finishes and colours.

FSB is echoing this trend in the design of its METRIC bathroom accessory series.

METRIC’s looks are consciously understated, being defined by geometric forms and premium materials. The stylistic contrast between round roses and rectangular-section supports is a thematic thread that runs through the entire series. The combination of the two simultaneously underscores the crisp structuring of the system’s constituent parts. Its astutely balanced proportions have a soothing effect and blend harmoniously with a variety of design concepts.

Ergonomic criteria have been taken into account wherever they are an aid to fluent sequences of movements. The holder for the toothbrush glass, for instance, tilts towards the user in a manner that facilitates the act of removing the glass.

METRIC is supplied in satin stainless steel. As well as being aesthetically pleasing, stainless steel exudes an authenticity that combines particularly well with natural materials such as wood and granite and makes it a firm contender for inclusion in quality bathroom schemes.

This dependable material has a justifiable reputation for being serviceable, corrosion-resistant, easy to look after and durable. The quality with which FSB works stainless steel is the upshot of many decades of experience gained from producing well-designed, superlatively engineered hardware for doors and windows.

We have now applied this proficiency in design and manufacture to the METRIC bathroom accessory series.

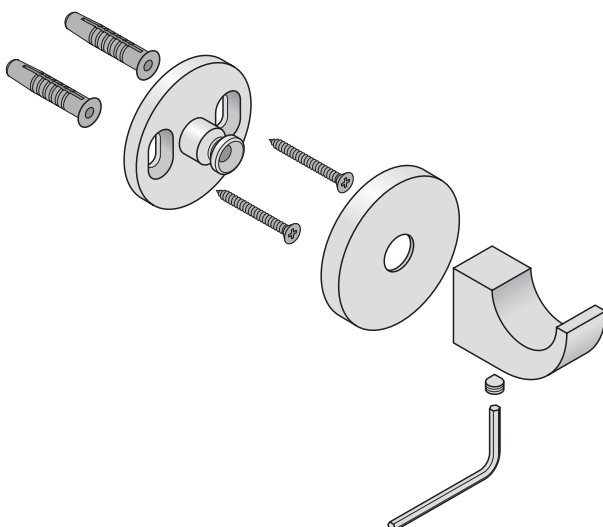

Fixing

The base rose (wall mounting) contains two parallel slots for optimum positioning and is screwed to the wall using the fixing material supplied.

The cover rose is then pressed home and the pattern aligned as required. Final visual adjustment of the functional components is performed by firmly tightening the hexagon socket screw against the tensioning bolt.



Overview



Page 8



Page 9



Page 9



Page 14



Page 10



Page 11



Page 11



Page 12



Page 12



Page 13



Page 13

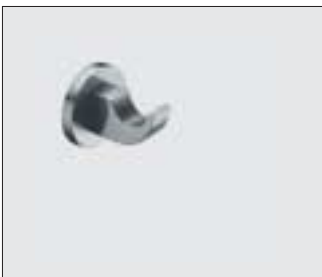

Page 15



Page 15



Page 15



Page 16



Page 17

METRIC



8270 0021

Stainless steel

Bath towel rail
double rail

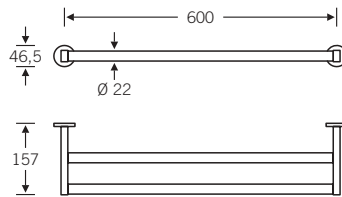

Specification details
cf. Pages 18 + 19

Bathroom Accessories



8270 0011

Stainless steel

Bath towel rail

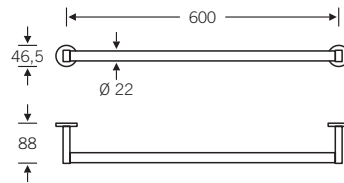

8270 0010

Stainless steel

Towel rail
double rail, swivel action

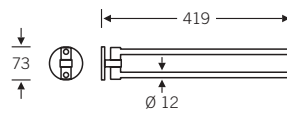

Specification details
cf. Pages 18 + 19

METRIC



8270 0015

Stainless steel
Glass

Utensils tray in frosted glass

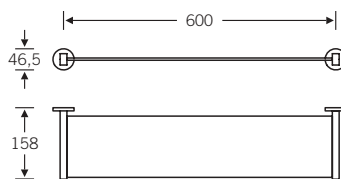
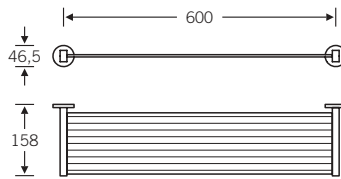

8270 0016

Stainless steel
Glass

Utensils tray in plain glass

Specification details
cf. Pages 18 + 19

Bathroom Accessories



8270 0041

Stainless steel
Glass

Glass holder with
toothbrush glass

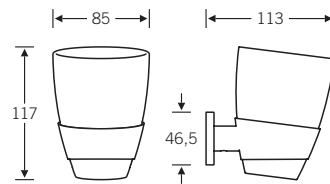

8270 0040

Stainless steel
Plastic

Soap holder with soap dish

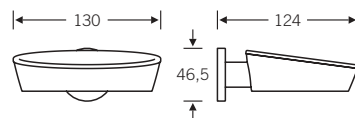

Specification details
cf. Pages 18 + 19

METRIC

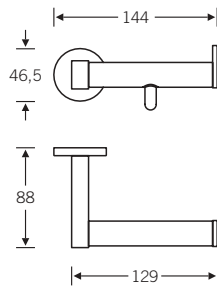

8270 0030

Stainless steel

Toilet roll holder with roll retainer

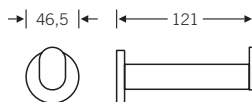

8270 0031

Stainless steel

Reserve toilet roll holder for one rolls

Specification details
cf. Pages 18 + 19

Bathroom Accessories



8270 0032

Stainless steel

Reserve toilet roll holder
for two rolls

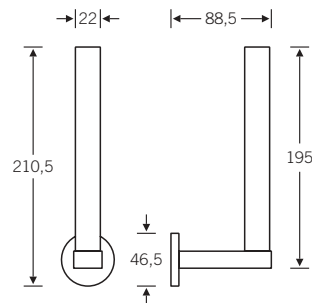

8270 0042

Stainless steel

Toilet brush set

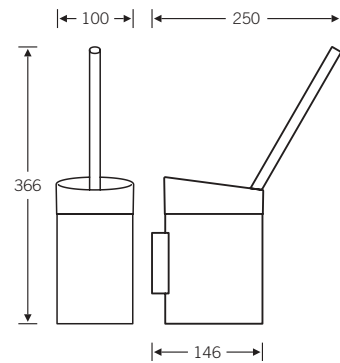

Specification details
cf. Pages 18 + 19

METRIC



8270 0050

Stainless steel

Shower rail with shower-head
bracket for wall fixing

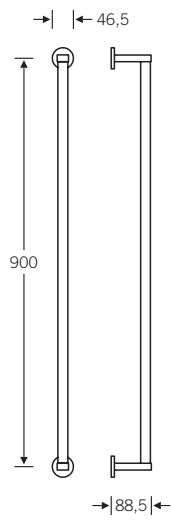

Specification details
cf. Pages 18 + 19

Bathroom Accessories

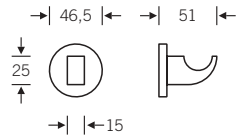

8270 0001

Stainless steel

Wall hook

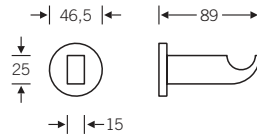

8270 0002

Stainless steel

Coat hook

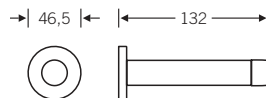

8270 0003

Stainless steel

Wall buffer

Specification details
 cf. Pages 18 + 19

METRIC



8241

Seat PUR
Frame stainless steel

Bath stool with
rotating seat

The height-adjustable bath stool with rotating seat is designed with comfort in mind. Propped up against the edge of the bath, it makes getting into the bath easier. Further bathroom functions such as body care or getting dressed/undressed are likewise facilitated.

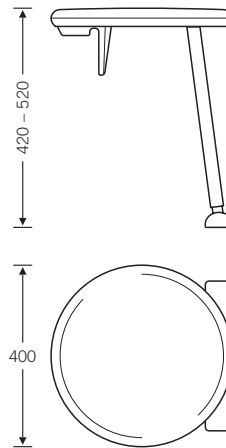

Specification details
cf. Pages 18 + 19

Bathroom Accessories

8243

Seat PUR
Frame stainless steel

Free-standing stool with
rotating seat

The free-standing stool has a rotating seat and is very convenient in the bathroom and for getting dressed/undressed.

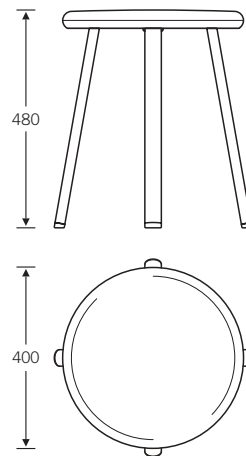

Specification details
cf. Pages 18 + 19

Specification details

8270 0001

FSB METRIC bathroom accessory, wall hook in satin stainless steel, wall mounting with concealed fixing by means of cover rose in satin stainless steel, Ø 46.5 mm, includes fixing material for solid masonry

Length 51 mm

8270 0002

FSB METRIC bathroom accessory, coat hook in satin stainless steel, wall mounting with concealed fixing by means of cover rose in satin stainless steel, Ø 46.5 mm, includes fixing material for solid masonry

Length 89 mm

8270 0003

FSB METRIC bathroom accessory, wall buffer in satin stainless steel, wall mounting with concealed fixing by means of cover rose in satin stainless steel, Ø 46.5 mm, includes fixing material for solid masonry

Length 132 mm

8270 0010

FSB METRIC bathroom accessory, towel rail in satin stainless steel, double washstand rail, Ø 12 mm, swivel action, wall mounting with concealed fixing by means of cover rose in satin stainless steel, Ø 70 mm, includes fixing material for solid masonry

Length 440 mm

8270 0011

FSB METRIC bathroom accessory, bath towel rail in satin stainless steel, Ø 22 mm, side-bearers in satin stainless steel, wall mountings with concealed fixing by means of cover roses in satin stainless steel, Ø 46.5 mm, includes fixing material for solid masonry

Length 600 mm

8270 0015

FSB METRIC bathroom accessory, utensils tray for washstand, in unbreakable glass (toughened safety glass), side-bearers in satin stainless steel, plastic wall mountings with concealed fixing by means of cover roses in satin stainless steel, Ø 46.5 mm, includes fixing material for solid masonry

Surface area of tray
600 x 135 mm
Frosted finish

8270 0016

FSB METRIC bathroom accessory, utensils tray for washstand, in unbreakable glass (toughened safety glass), side-bearers in satin stainless steel, plastic wall mountings with concealed fixing by means of cover roses in satin stainless steel, Ø 46.5 mm, includes fixing material for solid masonry

Surface area of tray
600 x 135 mm
Plain glass finish

8270 0021

FSB METRIC bathroom accessory, bath towel rail in satin stainless steel, double rail, Ø 22 mm, side-bearers in satin stainless steel, wall mountings with concealed fixing by means of cover roses in satin stainless steel, Ø 46.5 mm, includes fixing material for solid masonry

Length 600 mm

8270 030

FSB METRIC bathroom accessory, toilet roll holder in satin stainless steel, Ø 22 mm, with roll retainer, wall mounting with concealed fixing by means of cover rose in satin stainless steel, Ø 46.5 mm, includes fixing material for solid masonry

8270 0031

FSB METRIC bathroom accessory, reserve toilet roll holder in satin stainless steel, Ø 22 mm, for one roll, wall mounting with concealed fixing by means of cover rose in satin stainless steel, Ø 46.5 mm, includes fixing material for solid masonry

Specification details

8270 0032

FSB METRIC bathroom accessory, reserve toilet roll holder in satin stainless steel, Ø 22 mm, for two rolls, wall mounting with concealed fixing by means of cover rose in satin stainless steel, Ø 46.5 mm, includes fixing material for solid masonry

8270 0040

FSB METRIC bathroom accessory, soap holder in satin stainless steel, for washstand, with removable plastic soap tray (polycarbonate), wall mounting with concealed fixing by means of cover rose in satin stainless steel, Ø 46.5 mm, includes fixing material for solid masonry

8270 0041

FSB METRIC bathroom accessory, glass holder in satin stainless steel, for washstand, with removable glass beaker, ergonomic styling, tilting of holder conducive to ease of removal, wall mounting with concealed fixing by means of cover rose in satin stainless steel, Ø 46.5 mm, includes fixing material for solid masonry

8270 0042

FSB METRIC bathroom accessory, toilet brush set in satin stainless steel and plastic (polycarbonate), for wall fixing, nylon brush head, replaceable, brush is automatically centred and positioned, for removal in line with body movements, large insertion aperture, easy to clean due to removable brush receptacle, with inner reservoir for disinfectants, concealed fixing, includes fixing material for solid masonry

8270 0050

FSB METRIC bathroom accessory, shower rail in satin stainless steel, Ø 22 mm, with continuously adjustable shower head holder, supports in satin stainless steel, wall mountings with concealed fixing by means of cover rose in satin stainless steel, Ø 46.5 mm, includes fixing material for solid masonry

Length 900 mm

8241

FSB convenience stool in pleasant-on-the-skin, hygienic PUR and satin stainless steel, with rotating seat in PUR, Ø 400 mm, seat height-adjustable from 420 mm to 520 mm, max. loading 150 kg, for propping against the edge of the bath and, in combination with FSB bath seat, can be used as an aid to moving and getting in the bath

8243

FSB free-standing and convenience stool in pleasant-on-the-skin, hygienic PUR and satin stainless steel, with rotating seat in PUR, Ø 400 mm, seat height 480 mm, with four free-standing feet in stainless steel



Franz Schneider
Brakel GmbH + Co

FSB

Nieheimer Straße 38
33034 Brakel

Phone +49 5272 608-0
Fax +49 5272 608-300
www.fsb.de · info@fsb.de